



EM530/EM540

Energy analyzer for three-phase and two-phase systems

USER MANUAL

23/11/2022

Contents

This manual	3	DMD values	20
		Average value calculation (dmd)	20
EM530/EM540	4	Integration interval	20
Introduction	4	Example	20
Description	4	LCD display	20
Available versions	6	Home page	20
UCS (Universal Configuration Software)	7	Backlight	20
		Screensaver	21
Use	8	Page filter	21
Interface	8	Restoring the factory settings	22
Introduction	8	Restoring the settings using the RESET menu	22
SETTINGS menu display	8	Restoring the MID menu using the RESET menu	23
INFO menu display	8	WIRING CHECK function	24
RESET menu display	8	Introduction	24
Measurement page display	8	Display check	24
Information and warnings	9	Check from UCS software	24
		Virtual correction from UCS software or UCS Mobile	24
Working with EM530/EM540	10	Tariff management	24
Working with the measurement pages	10	Tariff management via digital input	24
Working with the SETTINGS menu	10	Tariff management Modbus RTU	24
Working with the INFO menu	10		
Working with the RESET menu	10	Maintenance and disposal	25
		Troubleshooting	25
Commissioning	11	Alarms	25
Preliminary settings	11	Communication problems	25
MID SETTINGS menu	11	Display problem	25
QUICK SETUP menu	11	Download	26
		Cleaning	26
Menu description	13	Responsibility for disposal	26
Measurement pages	13		
SETTINGS menu	14		
INFO menu	15		
RESET menu	17		
Input, output and communication	18		
Digital input	18		
Digital output (version O1)	18		
Modbus RTU port (version S1)	18		
M-Bus port (version M1)	18		
Essential information	19		
Alarms	19		
Introduction	19		
Variables	19		
Alarm types	19		

This manual

Information property

Copyright © 2022, CARLO GAVAZZI Controls SpA

All rights reserved in all countries.

CARLO GAVAZZI Controls SpA reserves the right to apply modifications or make improvements to the relative documentation without the obligation of advance notice.

Safety messages

The following section describes the warnings related to user and device safety included in this document:

NOTICE: indicates obligations that if not observed may lead to damage to the device.



CAUTION! Indicates a risky situation which, if not avoided, may cause data loss.



IMPORTANT: provides essential information on completing the task that should not be neglected.

General warnings



This manual is an integral part of the product and accompanies it for its entire working life. It should be consulted for all situations tied to configuration, use and maintenance. For this reason, it should always be accessible to operators.



NOTICE: no one is authorized to open the analyzer. This operation is reserved exclusively for CARLO GAVAZZI technical service personnel.

Protection may be impaired if the instrument is used in a manner not specified by the manufacturer.

Service and warranty

In the event of malfunction, fault, requests for information or to purchase accessory modules, contact the CARLO GAVAZZI branch or distributor in your country.

Installation and use of analyzers other than those indicated in the provided instructions void the warranty.

EM530/EM540

Introduction

EM530 is an energy analyzer connected through 5 A current transformers, for two- and three-phase systems up to 415 V L-L. EM540 is an energy analyzer for direct connection up to 65 A, for two- and three-phase systems up to 415 V L-L.

In addition to a digital input, the unit can be equipped, according to the model, with a static output (pulse or alarm), a Modbus RTU communication port or an M-Bus communication port.

Description

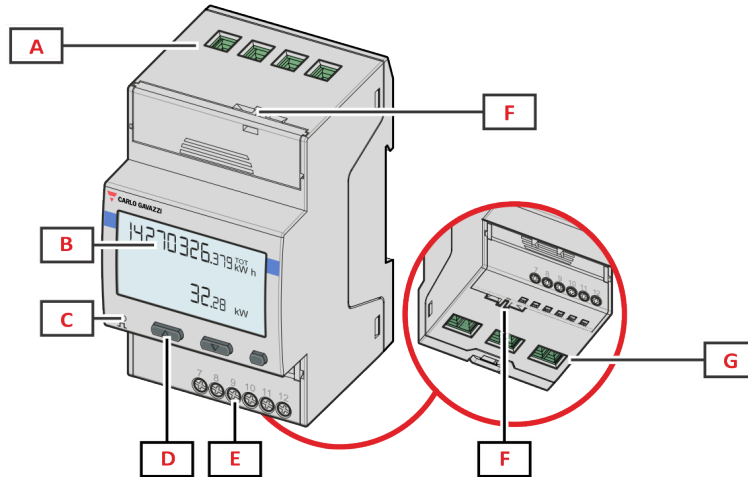

Figure 1 EM530- Front

Area	Description
A	Voltage inputs
B	Display
C	LED
D	Browsing and configuration buttons
E	Digital input, digital output and communication connections
F	MID seal housings
G	Current inputs

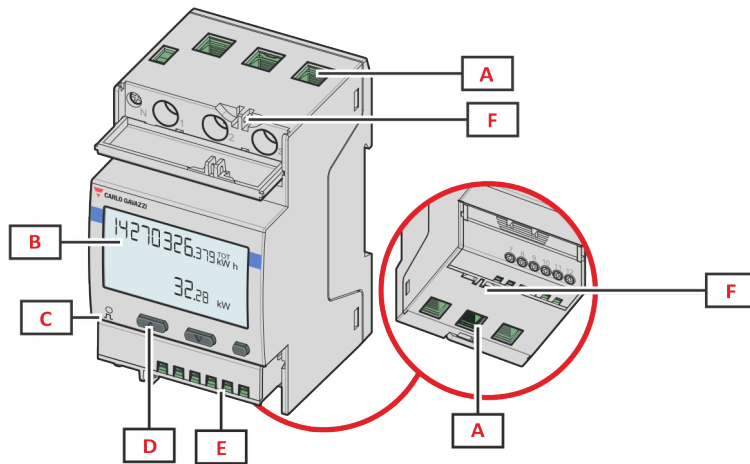

Figure 2 EM540- Front

Area	Description
A	Voltage/current inputs
B	Display
C	LED
D	Browsing and configuration buttons
E	Digital input, digital output and communication connections
F	MID seal housings

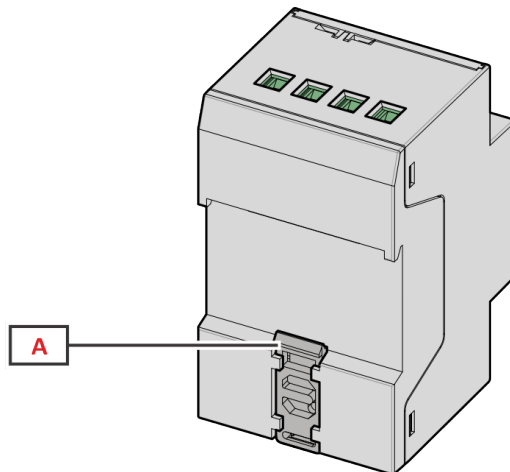

Figure 3 EM530/EM540 - Back

Area	Description
A	DIN rail mounting bracket

Available versions

Part number	Connection	Output	MID approval	cULus approval
EM530DINAV23XO1X	Via CT (5A secondary output)	Digital output		x
EM530DINAV23XS1X	Via CT (5A secondary output)	RS485 Modbus RTU		x
EM530DINAV23XM1X	Via CT (5A secondary output)	M-Bus		x
EM530DINAV23XO1PFA EM530DINAV23XO1PFB EM530DINAV23XO1PFC	Via CT (5A secondary output)	Digital output	x	
EM530DINAV23XS1PFA EM530DINAV23XS1PFB EM530DINAV23XS1PFC	Via CT (5A secondary output)	RS485 Modbus RTU	x	
EM530DINAV23XM1PFA EM530DINAV23XM1PFB EM530DINAV23XM1PFC	Via CT (5A secondary output)	M-Bus	x	

Part number	Connection	Output	MID approval	cULus approval
EM540DINAV23XO1X	Direct connection up to 65 A	Digital output		x
EM540DINAV23XS1X	Direct connection up to 65 A	RS485 Modbus RTU		x
EM540DINAV23XM1X	Direct connection up to 65 A	M-Bus		x
EM540DINAV23XO1PFA EM540DINAV23XO1PFB EM540DINAV23XO1PFC	Direct connection up to 65 A	Digital output	x	
EM540DINAV23XS1PFA EM540DINAV23XS1PFB EM540DINAV23XS1PFC	Direct connection up to 65 A	RS485 Modbus RTU	x	
EM540DINAV23XM1PFA EM540DINAV23XM1PFB EM540DINAV23XM1PFC	Direct connection up to 65 A	M-Bus	x	

PFA models

Easy connection function: irrespective of the current direction, the power always has a plus sign and contributes to increase the positive energy meter. The negative energy meter is not available.

PFB models

For each measuring time interval, the individual phase energies with a plus sign are summed to increase the positive energy meter (kWh+), while the others increase the negative one (kWh-).

Example:

P L1= +2 kW, P L2= +2 kW, P L3= -3 kW

Integration time = 1 hour

kWh+ = (2+2) x 1h = 4 kWh

kWh- = 3 x 1h = 3kWh

PFC models

For every measuring interval time, the energies of the single phases are summed; according to the sign of the result, the positive (kWh+) or negative totalizer (kWh-) is increased.

Example:

P L1= +2 kW, P L2= +2 kW, P L3= -3 kW

Integration time = 1 hour

kWh+ = (+2+2-3)x1h = (+1)x1h = 1 kWh

kWh+ = 0 kWh

UCS (Universal Configuration Software)

UCS is available in desktop and mobile versions.

It may connect to EM530 or EM540 via RS485 (RTU protocol, desktop version only).

UCS allows to:

- set up the unit (online or offline);
- display the system state for diagnostic and setup verification purposes

Overview of the UCS functions:

- Setting up the system with energy meter connected (online setup)
- Defining the setup with energy non connected, then applying it later (offline setup)
- Displaying the main measurements
- Displaying the state of inputs and outputs
- Displaying the state of the alarms
- Recording the measurements of selected variables
- Check connection and correct wiring errors

Use

Interface

Introduction

EM530/EM540 is organized into two menus:

- Measurement pages: pages allowing to display the energy meters and the other electrical variables
- Main menu, divided into three sub-menus:
 - » SETTINGS: pages allowing to set the parameters
 - » INFO: pages displaying general information and the set parameters
 - » RESET: pages allowing to reset the partial counters and the dmd calculation, or to restore the factory settings

SETTINGS menu display

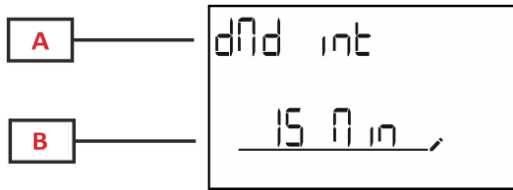

Part	Description
A	Sub-menu title, see "SETTINGS menu"
B	Parameter

INFO menu display

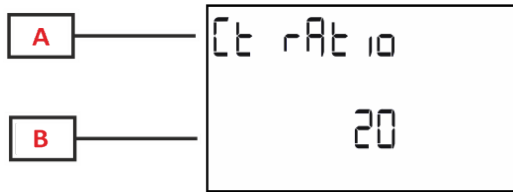

Part	Description
A	Sub-menu title, see "INFO menu"
B	Parameter

RESET menu display

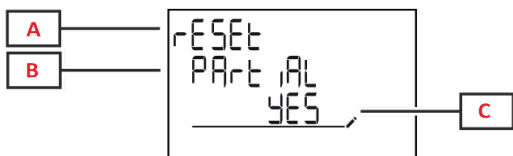



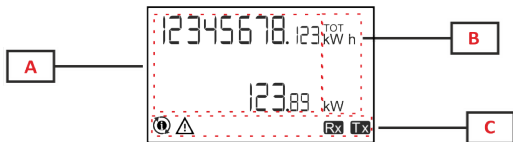

Part	Description
A	Menu title
B	Sub-menu title, see "RESET menu"
C	Selection (YES/NO)

Measurement page display





Part	Description
A	Measured values/data
B	Unit of measurement Note: for the "power factor" the unit indicates whether the value is inductive (L) or capacitive (C)
C	Information and diagnostics

Information and warnings



Symbol	Description
	ALARM (blinking icon): the value of the variable has exceeded the threshold set.
 	WIRING ERROR (steady icons): a wiring fault has been detected, the control operates correctly if the selected system is 3Pn and for each phase: <ul style="list-style-type: none">• the power is positive (imported),• PF > 0.7 L or PF > 0.96 C. (Only in EM530)
	Serial communication state (reception / transmission)
	The association of the phase terminal or the direction of the currents have been modified via UCS software to correct virtually a wiring fault. To view the current setup of the terminals, access the info screens (MENU > INFO > TERMINAL).

Working with EM530/EM540



Working with the measurement pages

Operation	Button
Scroll through the pages	
Enter the Main menu	



Working with the SETTINGS menu

Operation	Button
Scroll through the menu, edit the parameters	
Enter the sub-menu to edit and confirm the operation	

Working with the INFO menu

Operation	Button
Scroll through the menu	
Return to the main menu	

Working with the RESET menu

Operation	Button
Scroll through the menu	
Enter the sub-menu to edit and confirm the operation	

Commissioning

Preliminary settings

At switch-on, the device displays two preliminary setting menus:

- MID SETTINGS, for EM530, MID models only
- QUICK SETUP

MID SETTINGS menu

This procedure, only available in MID models, allows to program the current transformer ratio (CT ratio).

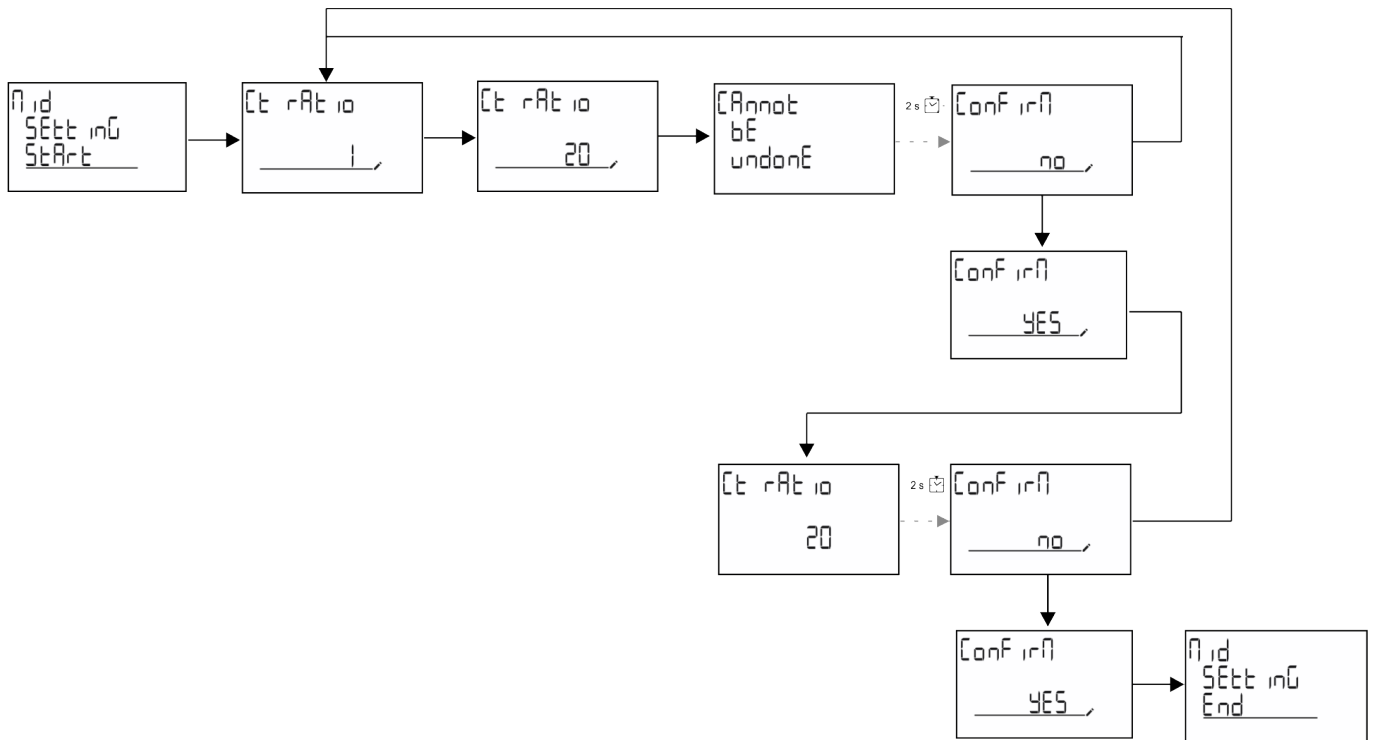

QUICK SETUP menu

This procedure is available when the instrument is switched on for the first time.

Note: the available parameters depend on the model.

In the “QUICK SETUP?” starting page

Select...	To...
Go	run the QUICK SETUP procedure
no	skip the procedure and no longer display the QUICK SETUP menu
LAtEr	skip the procedure and display the QUICK SETUP menu at the next switch-on

S1 models

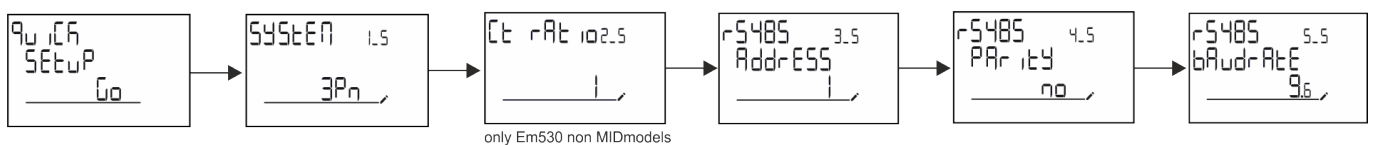

M1 models

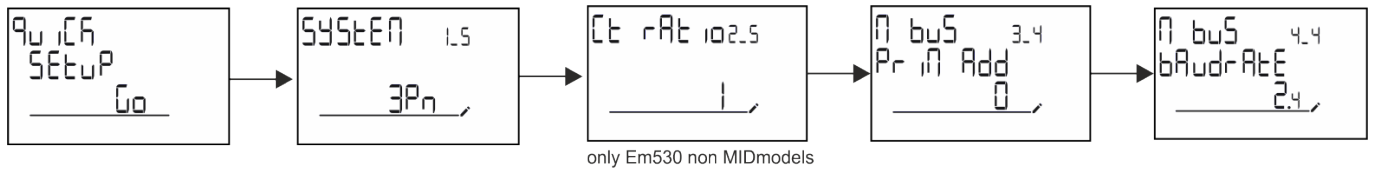

O1 models

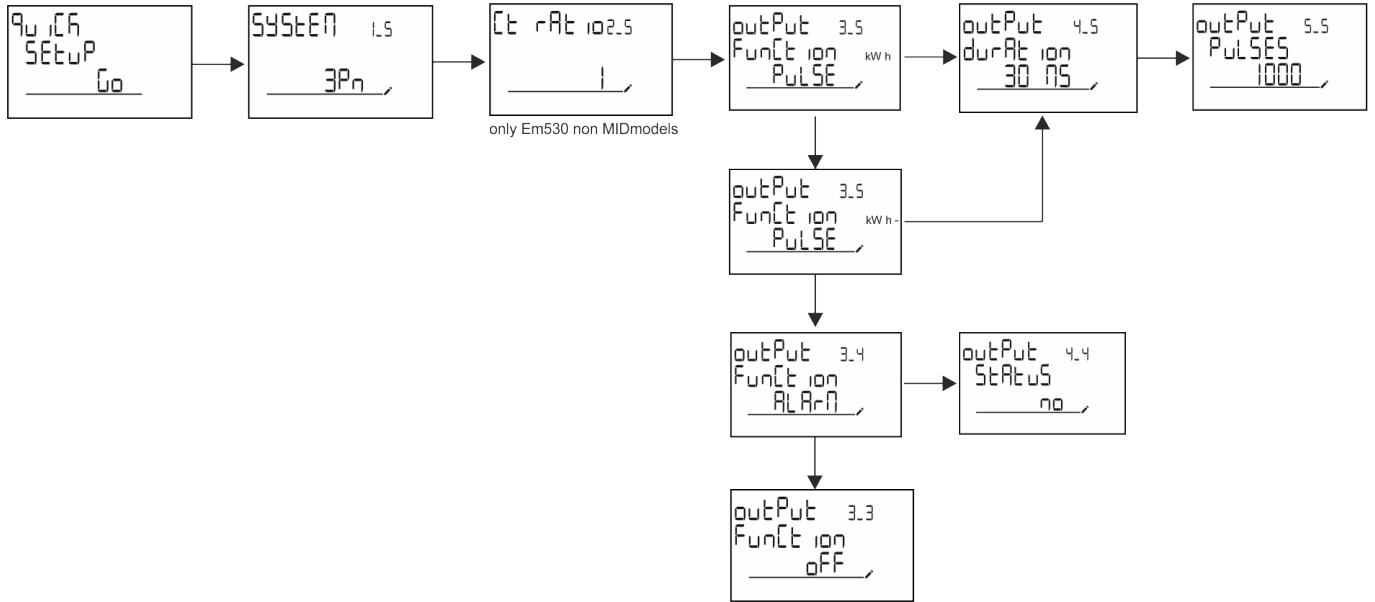

Menu description

Measurement pages

The displayed pages depend on the selected system.

Page	Displayed measurements	Description
1	kWh+ TOT kW	Imported active energy (TOTAL) System active power
2	kWh- TOT kW	Exported active energy (TOTAL) System active power
3	kWh+ TOT kWh+ PAR kW	Imported active energy (TOTAL) Imported active energy (PARTIAL) System active power
4	kWh+ TOT kW PF	Imported active energy (TOTAL) System active power System power factor
5	VLN VLL Hz	System line-line voltage System line-neutral voltage Frequency
6	kWh+ TOT kW kW sys DMD P	Imported active energy (TOTAL) System active power Peak demand System active power
7	kvarh TOT kvar	Imported reactive energy (TOTAL) System reactive power
8	kvarh- TOT kvar	Exported reactive energy (TOTAL) System reactive power
9	kVAh TOT kW kVA	Apparent energy (TOTAL) System active power System apparent power
10	kWh TOT h TOT kW	Imported active energy (TOTAL) Run hour meter (kWh+) TOTAL System active power
11	kWh- TOT h- TOT kW	Exported active energy (TOTAL) Run hour meter (kWh-) TOTAL System active power
12	kWh PAR h PAR kW	Imported active energy (PARTIAL) Run hour meter (kWh+) PARTIAL System active power
13	kWh- PAR h- PAR kW	Imported active energy (PARTIAL) Run hour meter (kWh-) PARTIAL System active power
14	kWh+ TOT kWh T1 kW	Imported active energy (TOTAL) Imported active energy tariff 1 System active power
15	kWh+ TOT kWh T2 kW	Imported active energy (TOTAL) Imported active energy tariff 2 System active power
16	Thd Ln	THD of phase 1 voltage THD of phase 2 voltage THD of phase 3 voltage
17	Thd LL	THD of phase 1-phase2 voltage THD of phase2-phase3 voltage THD of phase3-phase1 voltage
18	Thd A	THD of phase 1 current THD of phase 2 current THD of phase 3 current
19	nEutrAL CurrEnt	Neutral current

Page	Displayed measurements	Description
20	L1 kVA L2 kVA L3 kVA	Phase 1 apparent power Phase 2 apparent power Phase 3 apparent power
21	L1 kvar L2 kvar L3 kvar	Phase 1 reactive power Phase 2 reactive power Phase 3 reactive power
22	L1 PF L2 PF L3 PF	Phase 1 power factor Phase 2 power factor Phase 3 power factor
23	L1-N V L2-N V L3-N V	Phase 1 voltage Phase 2 voltage Phase 3 voltage
24	L1-2 V L2-3 V L3-1 V	Phase 1-phase 2 voltage Phase 2-phase 3 voltage Phase 3-phase 1 voltage
25	L1 A L2 A L3 A	Phase 1 current Phase 2 current Phase 3 current
26	L1 kW L2 kW L3 kW	Phase 1 active power Phase 2 active power Phase 3 active power
27	L1 kWh TOT L2 kWh TOT L3 kWh TOT	Active energy phase 1 Active energy phase 2 Active energy phase 3

SETTINGS menu

This menu allows to set the parameters.

Page title	Sub-menu	Description	Values	Default values	Note
SYSTEM	-	System	3P+N 3P 2P	3P+N	
CT RAT	-	(CT) current transformer ratio	1 to 2000	1	Non-MID, AV5 models only
MEASurE	-	Measurement mode	A B C	A	Non-MID models only
dMd int	-	DMD interval	1 min 5 min 10 min 15 min 20 min 30 min 60 min	15 min	
inPut	Function	Digital input function	Tariff: tariff management Status: remote status P reset: partial meters reset P StArt: partial meter start/stop	Status	
RS485	AddrESS	Address	1 to 247	1	S1 models only
	PARity	Parity	NO/EVEN	no	
	bAudrAtE	Baudrate	9.6 kbps 19.2 kbps 38.4 kbps 57.6 kbps 115.2 kbps	9.6 kbps	
	StoP bit	Stop bit	1 or 2	1	

Page title	Sub-menu	Description	Values	Default values	Note
M bus	Pri Add	Primary address	1 to 250	0	M1 models only
	bAudrAtE	Baudrate	0.3 kbps 2.4 kbps 9.6 kbps	2.4 kbps	
Output	Function	Function	Off PuLSE (kWh+): pulse output linked to kWh+ PuLSE (kWh-): pulse output linked to kWh- ALArM: linked to alarm status	PuLSE (kWh+)	O1 models only
	durAtion	Pulse duration	30 ms 100 m	30 ms	
	PuLSES	Pulse weight (pulses/kWh)	0.1/1/10/100/500/1000	1000	
	StAtuS	Output status	No (normally open) Nc (normally closed)		
ALARM	EnAbLE	Enable	YES/no	no	
	VAriAbLE	Monitored variable	kW A V L-N V L-L PF Kvar kVA	kW	
	SEt 1	Activation threshold	-15000 to 15000	0.00	
	SEt 2	Deactivation threshold	-15000 to 15000	0.00	
	dELAY	Activation delay	0 to 3600 s	0	
dISPLAY	LIghT	Timer for backlight switch-off	On: always on 1 min 2 min 5 min 10 min 15 min 30 min 60 min oFF: always off	On	
	SC SAVER	Screensaver enabling, see "Screensaver" on page 21	oFF SLidE: slideshow home: homepage	home	Non-MID models only
	HOME	homepage	1 to 27	1	Non-MID models only
	PAGES	Measurement page filter enabling, see "Page filter" on page 21	ALL FiLteR	OFF	
	WirinG	Wiring check enabling	on/OFF	on	
PASS		Password enabling for the SETTINGS and RESET menu	0 (not protected) to 9999	0 (NOT PROTECTED)	
End	-	Exit	-	-	

INFO menu

This menu allows to display the set parameters.

Page	Page title	Description	Notes
1	YEAr	Production year	
2	SEriAL n	Serial number	
3	FW REV	FW revision	

Page	Page title	Description	Notes
4	Led PuLS	LED pulse weight	
5	SyStEM	Electrical system	
6	Ct rAtio	CT ratio	EM530 only
7	MEAsurE	Measurement type	
8	dMd int	Demand calculation interval	
9	Input Function	Digital input function	
10	rS 485 AddrESS	Address	S1 versions only
11	rS485 bAudrAtE	Baudrate (kbps)	S1 versions only
12	rS485 PARity	Parity	S1 versions only
13	rS485 StoP bit	Stop bit	S1 versions only
14	M buS PriM Add	M-Bus primary address	M1 versions only
15	M bus bAudrAte	M-Bus baudrate	M1 versions only
16	M bus SEC Add	M-Bus secondary address	M1 versions only
17	output Function	Digital output function	O1 versions only
18	Output StAtuS	Current output status	O1 versions only
19	output duration	Pulse output duration	O1 versions only
20	Output PuLSE	Output pulse weight	O1 versions only
21	ALARm EnAbLe	Alarm enabling	
22	ALARm VArIAbLE	Linked variable	
23	ALARm SEt 1	Alarm activation set point	
24	ALARm SEt 2	Alarm deactivation set point	
25	ALARm dELAY	Alarm activation delay	
26	display LIGHT	Backlight timer	
27	display SC SAVER	Screensaver type	
28	display home	Home page	
29	display PAGES	Page filter enabling	
30	display WirinG	Wiring check enabling	
31	tAriFF	Tariff management	
32	CHECKSuM	Firmware checksum	
33	WiRinG	Wiring check code to correct errors	

Page	Page title	Description	Notes
34	terminal	Screw terminal phase assignment (press enter to see)	
35	On time	Total working time	
36	End	Exit	

RESET menu

This menu allows to reset the following settings:

Page	Page title	Description
1	PArTiAL	It resets the partial meters
2	DMD	It resets the dmd calculation
3	tArIFF	It restores the factory settings
4	total	It resets the total meters (only non MID)
5	FACtorY	It resets the device to factory settings. In case of MID models all parameters are restored except CT ratio.
6	MID ReS	In MID models, it resets the CT ratio settings re-enabling first programming menu. This option is available only if the value of the total active energy is below 1 kWh.
7	End	Exit

Input, output and communication

Digital input

The digital input can perform four functions:

Function	Description	Parameters	
Tariff management	Digital input used to manage the tariff	-	
	Digital input status		Tariff
	Open		Tariff 1
	Closed		Tariff 2
Remote status	Digital input is used to check the status via Modbus or M-Bus.	-	
	Digital input status		Register 300h
	Open		0
	Closed		1
Partial meters start/stop	Digital input is used to enable/disable the reset of partial meters	-	
	Digital input status		Partial meter
	Open		Disabled (in pause)
	Closed		Enabled
Partial meter reset	Digital input is used to enable/disable the increasing of partial meters	-	
	Digital input status		Action
	Open		No action
	Closed		After 3 seconds, reset partial meters

Digital output (version O1)

The digital output can perform two functions:

Function	Description	Parameters
Alarm	Output associated with the alarm	Output state when no alarm is active
Pulse output	Pulse transmission output for imported active energy consumptions.	<ul style="list-style-type: none">• Linked energy (kWh+, kWh-)• Pulse weight• Pulse duration

Modbus RTU port (version S1)

Modbus RTU communication port is used to transmit data to a Modbus master (Carlo Gavazzi UWP3.0 or any SCADA, PLC, BMS, etc).

For further information about Modbus RTU communication refer to the communication protocol.

M-Bus port (version M1)

M-Bus communication port is used to transmit data to a M-Bus master (Carlo Gavazzi SIU-MBM or any third party M-Bus master).

For further information about M-Bus communication refer to the communication protocol.

Essential information

Alarms

Introduction

EM500 manages a measured variable alarm. To set the alarm, define:

- the variable to be monitored (**VARIABLE**)
- alarm activation threshold value (**SET POINT 1**)
- alarm deactivation threshold value (**SET POINT 2**)
- alarm activation delay (**ACTIVATION DELAY**)

Variables

The unit can monitor one of the following variables:

- system active power
- system apparent power
- system reactive power
- system power factor
- phase-neutral voltage (OR logic)
- phase-phase voltage (OR logic)
- current (OR logic)

Note: if you select a current or a voltage, the analyzer simultaneously monitors all the phases available in the set measurement system and triggers the alarm when at least one of the phases is in alarm (OR logic)

Alarm types

Up alarm (Set point 1 \geq Set point 2)

The alarm activates when the monitored variable exceeds the Set 1 value for a time equal to the activation delay (Delay) and deactivates when the values drops below Set 2.

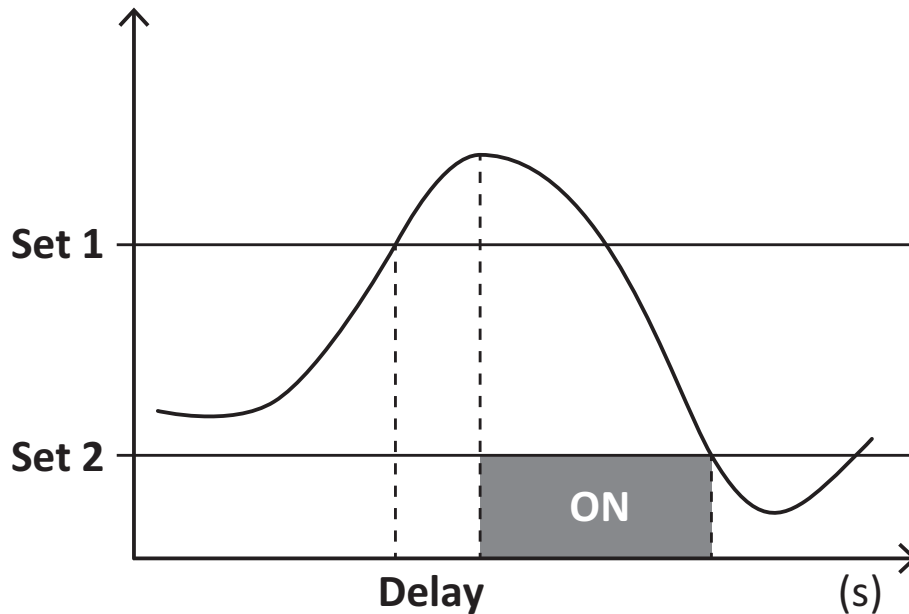

Down alarm (Set point 1 < Set point 2)

The alarm activates when the monitored variable drops below the Set 1 value for a time equal to the activation delay (Delay) and deactivates when it exceeds Set 2.

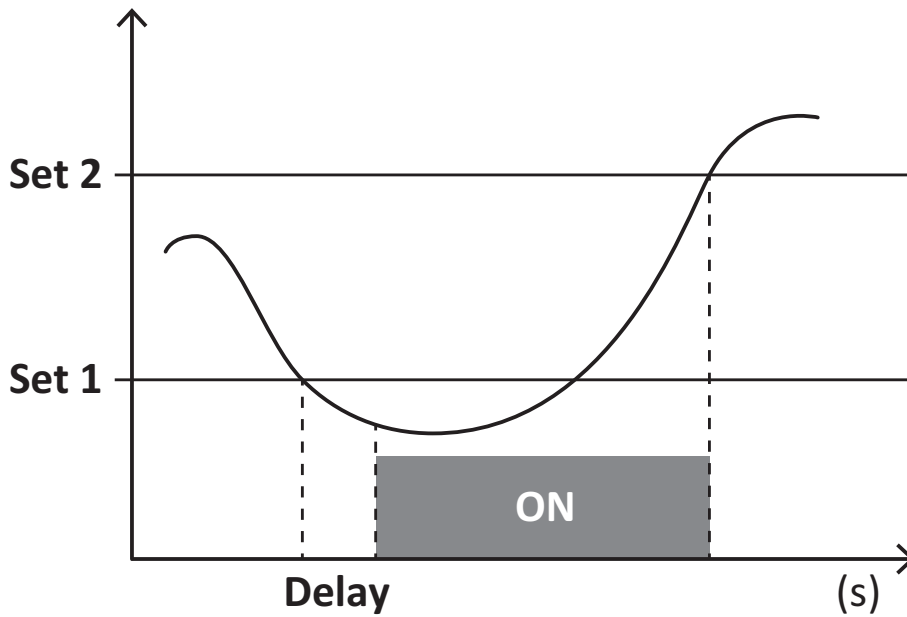

DMD values

Average value calculation (dmd)

EM530/EM540 calculates the average values of the electrical variables within a set integration interval (15 min by default).

Integration interval

The integration interval starts at switch-on or when the reset command is issued. The first value is displayed at the end of the first integration interval.

Example

The following is a sample integration:

- reset at 10:13:07
- set integration time: 15 min.

The first value displayed at 10:28:07 refers to the interval from 10:13:07 to 10:28:07.

LCD display

Home page

The unit may display the default measurement pages after no operation has been performed for five minutes, if the screensaver is enabled and the screensaver type is as “Home page” (default value).

Notes: if you select a page that is not available in the set system, the unit displays as its home page the first available page. In MID models the home page cannot be changed and displays the active energy meter.

Backlight



EM530/EM540 is equipped with a backlight system. You can set whether the backlight shall always be ON or whether it should automatically switch off after a given interval has elapsed since a button was pressed (1 to 60 minutes).

Screensaver

If the SCREENSAVER function is enabled (default setting), after 5 minutes have elapsed since a button was pressed the unit will display the home page if the screensaver type is "Home page" (default setting), or it shall activate the slideshow function, which displays the selected pages on a rotating basis.

Notes: In MID models the screensaver setting is "Homepage" and cannot be changed.

Page filter

The page filter makes it easier to use and browse the measurement pages. When you use the   buttons, the unit shall only display the pages you are most interested in, which can be selected through the UCS software (S1 version) or is pre-defined (O1 and M1 version)

Note: to display all the pages without using the UCS software, you can disable the page filter from the SETTINGS MENU (DISPLAY → PAGES → ALL). By default, the pages included in the filter are: 1 (kWh+ TOT, kW), 2 (kWh- TOT, kW), 5 (VLN, VLL, Hz), 7 (kvarh+ TOT, kvar), 8 (kvarh- TOT, kvar), 25 (L1 A, L2 A, L3 A), see "Measurement pages" on page 13.

Restoring the factory settings

Restoring the settings using the RESET menu

From the RESET menu you can restore all the factory settings. At start-up the QUICK SET-UP menu shall be available again.

Notes: meters are not reset. In MID models you cannot reset the CT current transformer ratio (CT RATIO).

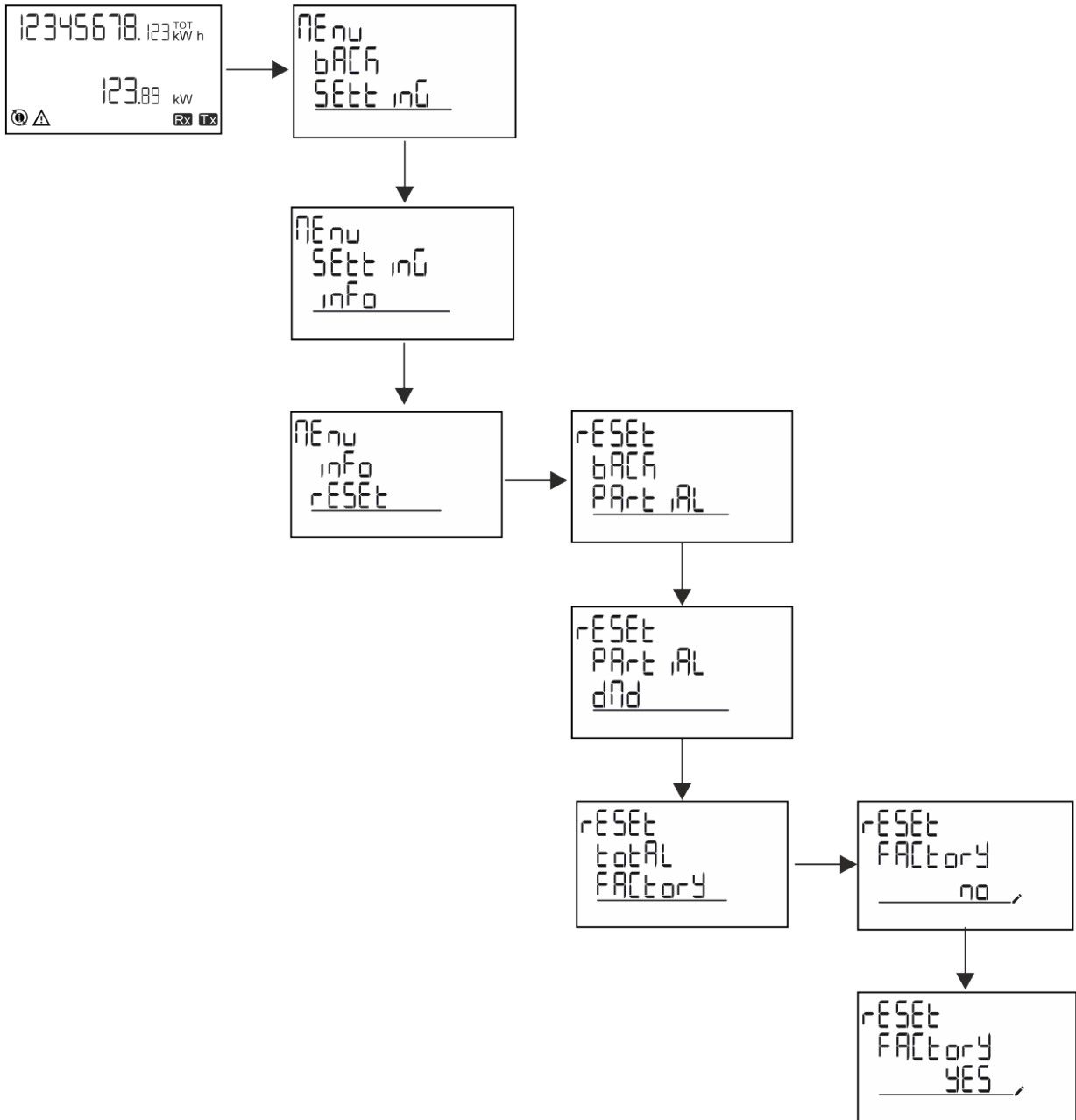

Restoring the MID menu using the RESET menu

To change the set CT ratio and restore the MID settings menu shown at first power on EM530 MID models, enter the reset menu and confirm "MID res".

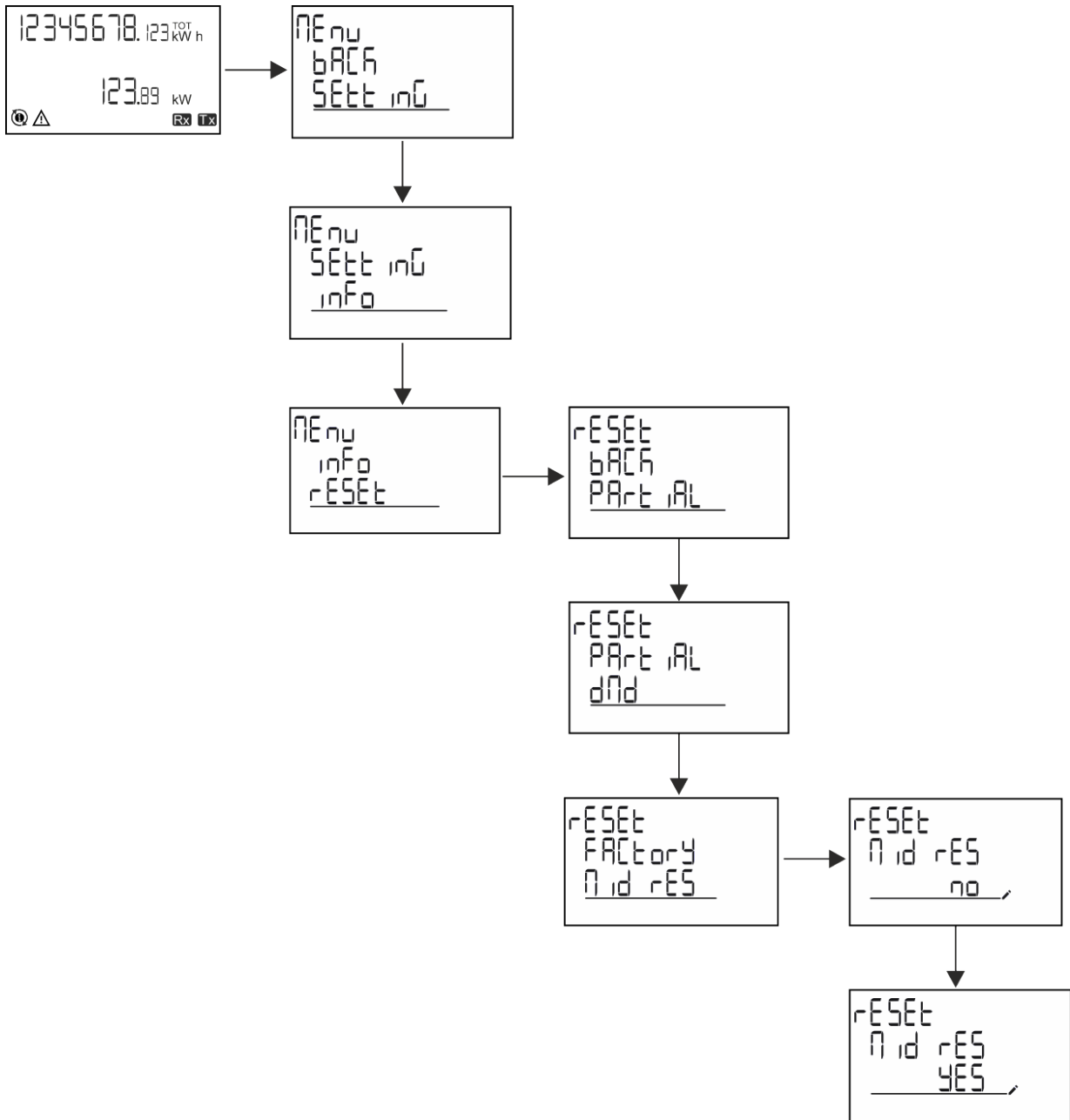

Note: in MID models the reset can only be performed if the energy meter has not exceeded 1 kWh. In case of wrong settings, you can then correct any CT current transformer setting errors (CT ratio), reactivating the MID programming menu.

Notes: if active energy has exceeded 1 kWh, the CT ratio cannot be changed.

WIRING CHECK function

Introduction

The WIRING CHECK function allows to check and correct the connections.
For it to work properly, the following three conditions must be met:

1. the set system must be "3P+N",
2. all voltages must be connected,
3. All currents must be greater than zero, with an offset ranging between a 45° lag and a 15° lead (power factor > 0.7 inductive or > 0.96 capacitive)

Display check

During operation, if a wiring error is detected the alarm icon will light up.

If the three conditions fail to be met, the following indications shall be displayed in the WIRING info page:

- V MISSING: at least one voltage is missing
- I MISSING: at least one current is missing
- PF OUT OF RANGE: the current-voltage offset is out of range.

Check from UCS software

By connecting to the analyzer through the UCS software or UCS Mobile, you can verify the connections and perform the steps required to correct the wiring error.

Virtual correction from UCS software or UCS Mobile

The virtual correction function allows to calculate the wiring error solution and to modify the association of the physical connections with the measurement references.

Example

if the connections of terminals 5 and 6 are inverted (voltage 2 and voltage 3), by accepting the proposed solution, voltage 2 shall be the one measured with reference to terminal 6, while voltage 3 shall be the one referring to terminal 5.

The unit shall display the  icon, signalling that the association was modified via software and referring to the info pages to check the phase-terminal associations set by UCS.

Note: the function is not available in MID models

Tariff management

Tariff management via digital input

To manage tariffs using the digital input set the function of the digital input as tariff (via keypad or UCS software). The current tariff depends on the status of the input

Digital input status	Tariff
Open	Tariff 1
Closed	Tariff 2

Tariff management Modbus RTU

To manage tariffs using the Modbus RTU command enable tariff management via Modbus command from UCS software

Digital input status	Tariff
0	No tariff
1	Tariff 1
2	Tariff 2

Maintenance and disposal

Troubleshooting

Note: in case of other malfunctions or of any failure, please contact the CARLO GAVAZZI branch or the distributor for your country

Problem	Cause	Possible solution
The 'EEEE' indication is displayed instead of a measurement	The analyser is not used within the prescribed measuring range; as a consequence, the measurement exceeds the maximum permitted value or is the result of a calculation with at least one measurement in error.	Uninstall the analyser
	The analyser has just been switched on and the interval defined for the calculation of the average power values (default: 15 min) has not expired yet.	Wait. If you wish to change the interval, access the Dmd page of the Settings menu
The displayed values are not the expected ones	Electrical connections are incorrect	Verify the connections
	The current transformer settings are incorrect	Check the set current transformer ratio

Alarms

Problem	Cause	Possible solution
An alarm is triggered, but the measurement has not exceeded the threshold value	The value with which the alarm variable is calculated is in error	Check the set current transformer parameters
The alarm is not activated and deactivated as expected	The alarm settings are incorrect	Check the set parameters

Communication problems

Problem	Cause	Possible solution
No communication can be established with the analyser	Communication settings are incorrect	Check the set parameters
	Communication connections are incorrect	Verify the connections
	The settings of the communication device (third-party PLC or software) are incorrect	Check the communication with the UCS software

Display problem

Problem	Cause	Possible solution
You cannot display all measurement pages	The page filter is enabled	Disable the filter, see "Page filter" on page 21

Download

This manual	https://gavazziautomation.com/images/PIM/MANUALS/ENG/EM500_IM_EN_USE.pdf
EM530 installation manual	https://gavazziautomation.com/images/PIM/MANUALS/ENG/EM530_IM_INST.pdf
EM530 datasheet	https://gavazziautomation.com/images/PIM/DATASHEET/ENG/EM530_DS_ENG.pdf
EM540 installation manual	https://gavazziautomation.com/images/PIM/MANUALS/ENG/EM540_IM_INST.pdf
EM540 datasheet	https://gavazziautomation.com/images/PIM/DATASHEET/ENG/EM540_DS_ENG.pdf
UCS desktop	www.productselection.net/Download/UK/ucs.zip
UCS Mobile	Google Play Store

Cleaning

To keep the display clean, use a slightly wet cloth. Never use abrasives or solvents.

Responsibility for disposal



Dispose of the unit by separately collecting its materials and bringing them to the facilities specified by government authorities or by local public bodies. Proper disposal and recycling will help preventing potentially harmful consequences for the environment and for people.



CARLO GAVAZZI Controls SpA

via Safforze, 8
32100 Belluno (BL) Italy

www.gavazziautomation.com
info@gavazzi-automation.com
info: +39 0437 355811
fax: +39 0437 355880

